

**CBP20**

Cover Available

Made in Taiwan

Electrical Rating	15A 300VAC
Housing Material	Plastic NYLON 66, Black (UL 94V-0)
Terminal	Brass, 0.8t Tin Plated
Screw	Steel, M3.5, Nickel Plated
Working Temperature	-40°C to +105°C
Insulation withstand Voltage	AC2000V at 1 min
Insulation resistance	500MΩ or more at DC 500V
Wire Range	22~12 AWG
Max. Torque Value	12Kg/cm
Number of Poles	2P~32P
Pitch (terminal to terminal)	9.5mm



**CBP20-01**

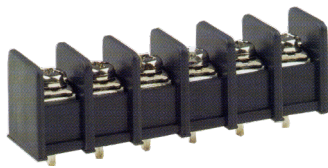
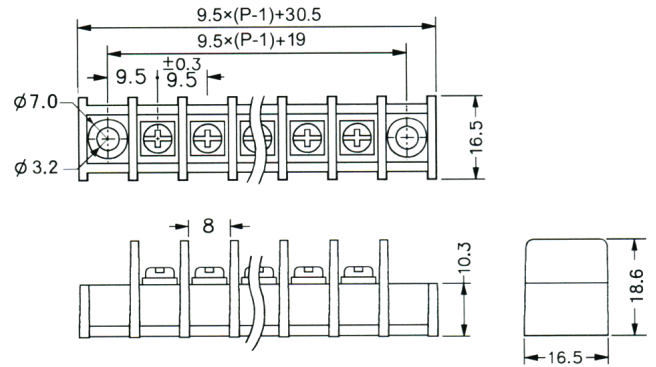

**CBP20-02**

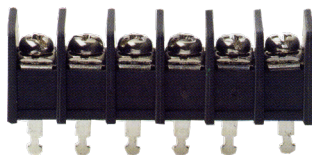
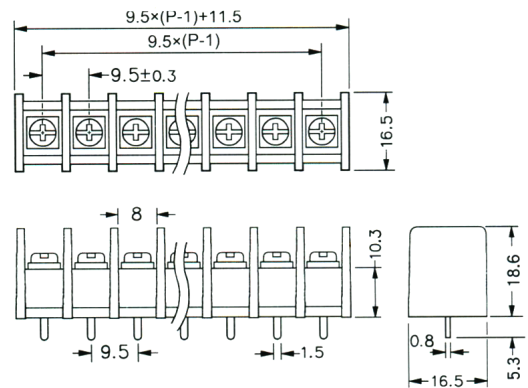

**CBP20-03**

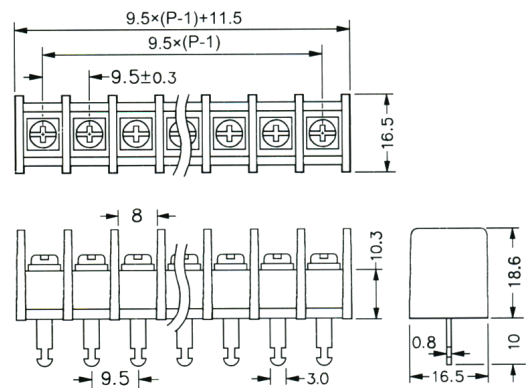

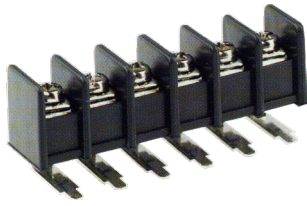

**CBP20-04**

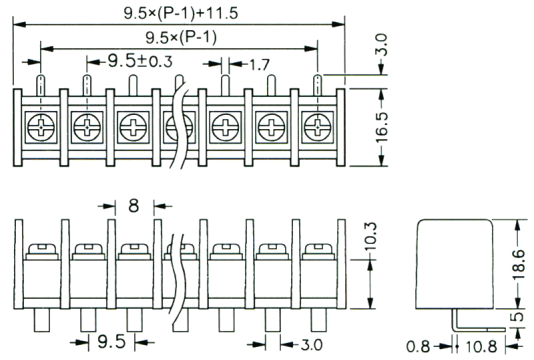

Unit : mm



**CBP20-05**

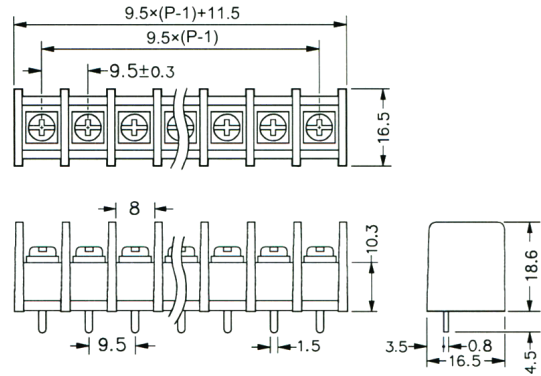

Unit : mm

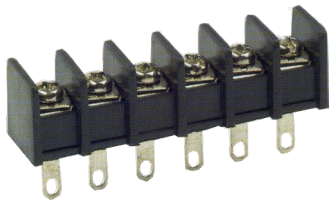

**CBP20-06**

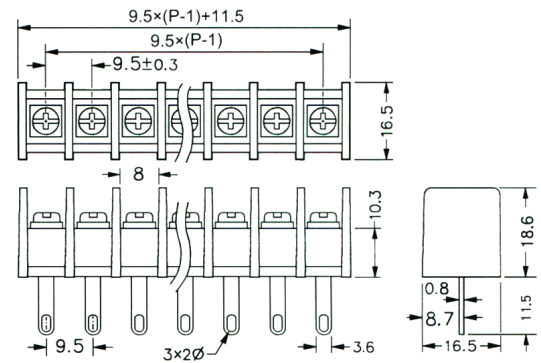

Unit : mm

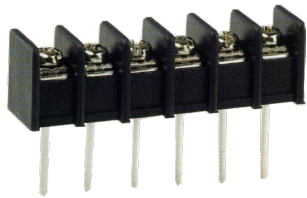

**CBP20-07**

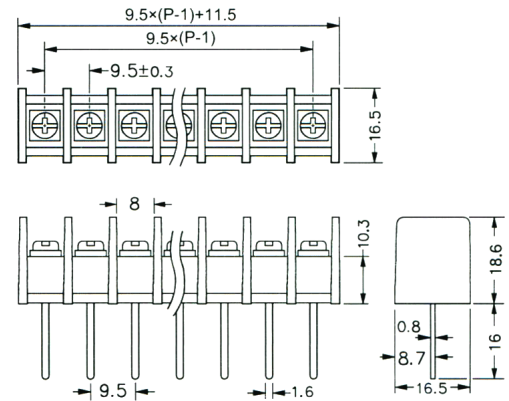

Unit : mm